



Open Communication Interface for Road Traffic Control Systems

Offene Schnittstellen für die Straßenverkehrstechnik

# **OCIT-C Center to Center Message Definition Exchange**

OCIT-C\_MessageDefinition\_exchange\_V2.1\_A01

**OCIT Developer Group (ODG) & Partner**

OCIT® is a registered trademark of the companies AVT Stoye, Stührenberg, Swarco Traffic Systems and Yunex Traffic

# OCIT-C Center to Center Message Definition Exchange

Document: OCIT-C\_MessageDefinition\_exchange\_V2.1\_A01

Issued by: ODG & Partner

Contact: [www.ocit.org](http://www.ocit.org)

Copyright © 2024 ODG. Subject to modifications. Documents with a more recent version or revision level replace all contents of the previous versions.



# Contents

<b>1</b>	<b>MELDUNGSDEFINITION .....</b>	<b>6</b>
1.1	Version und Sprache der Meldungen .....	6
1.2	Definition der Meldungsklasse .....	7
1.3	Definition der Meldungen einer Meldungsklasse .....	7
1.4	Meldungsparameter .....	9
1.5	Schweregrade.....	<b>Fehler! Textmarke nicht definiert.</b>
1.6	Meldungskategorien.....	10
1.7	Aufzählungen .....	11

**Document history**

<b>Version State</b>	<b>Date</b>	<b>Distribution List</b>	<b>Comments</b>
V2.1_A01	29.04.2024	PUBLIC	For OCIT-C V2.1 ODG Homepage

# 1 Message Definition

In the operating reports themselves, numerical and textual identifiers are used to reference the message, its parameters, the severity and the message category. This allows the message to be output in multiple languages. On the other hand, the text of the message and the formal structure of the report must be known. For this purpose, the definition of the messages is exchanged offline on a project-specific basis. Normally, the sender of the message creates the message definition, which allows the recipient of the message to process the message in his message database.

## 1.1 Version and language of the messages

The message definitions are exchanged offline (i.e. not via put/get/inquireAll) in a file in XML format. The file contains a list of message definitions for different languages.

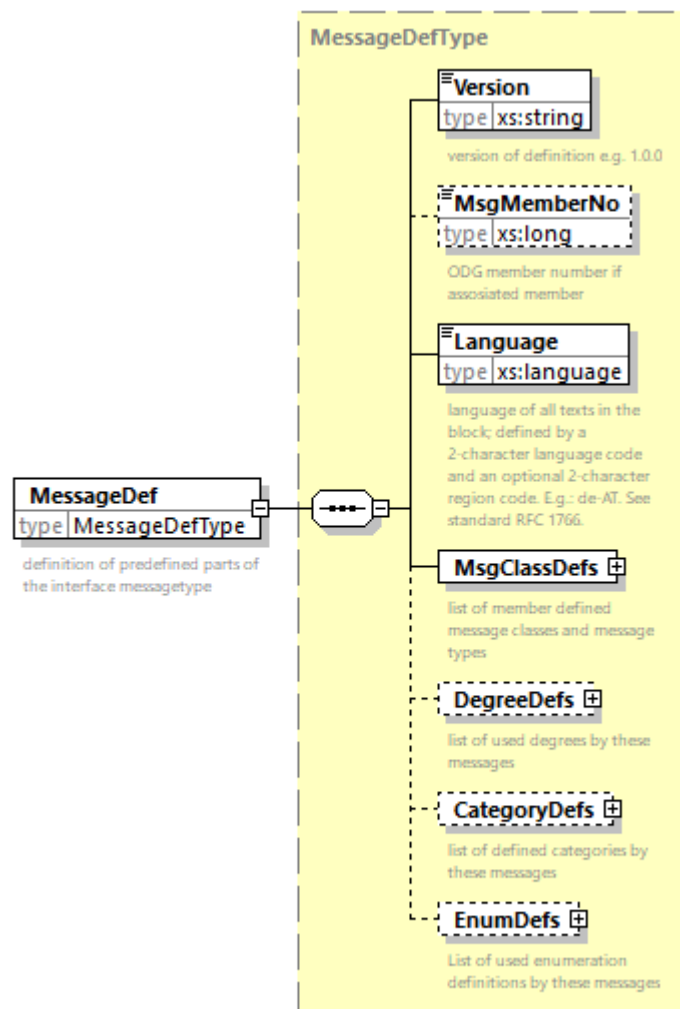

Generated by XMLSpy

www.altova.com

Tag	Description
Version	Version number of the message definition file. Assigned by the creator of the file.

Tag	Description
MsgMemberNo	If the creator of the message file is a member of the ODG, the member number should be entered here.
Language	the language of the message texts contained in this definition; defined by a two-digit language code and an optional two-digit region code. E.g.: de-AT. See Standard RFC 1766.

## 1.2 Definition of the message class

The list of version and language definitions contains a list of message classes. The notification class is used to distinguish between different message groups of a manufacturer.

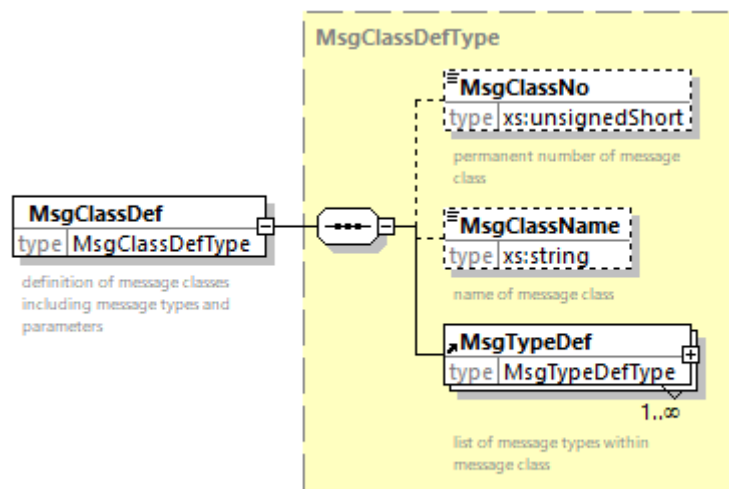

Generated by XMLSpy

www.altova.com

Tag	Description
MsgClassNo	Number of the manufacturer's notification class
MsgClassName	Descriptive name of the message class in the respective language.

### 1.3 Definition of Messages of a Notification Class

A message class contains a list of message definitions.

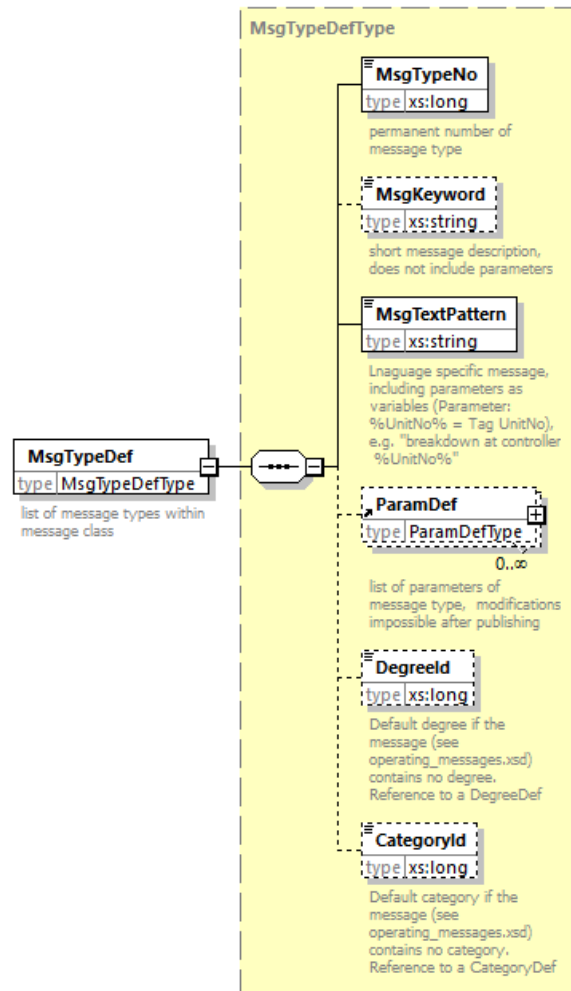

Generated by XMLSpy

www.altova.com

Tag	Description
MsgTypeNo	Alert number. The exchange of this definition file is the basis for the exchanged message numbers.  Together with the <code>MsgMemberNo</code> , the <code>MsgTypeNo</code> uniquely identifies the message.
MsgKeyword	Short name of the message without parameters in the respective language.
MsgTextPattern	Message text in the respective language with parameter names as variables. The parameter names are bracketed with percent signs (one before and one after the name).
DegreeId	Default severity of the message, if the message itself does not contain a



Tag	Description
	severity.
CategoryId	Default category of the message, if there is no category in the message itself.

#### 1.4 Message Parameters

A message can contain parameters. The current value of the parameters in the message is a string that replaces the variable in the message body. If possible, parameters containing a text should be defined as a bulleted list so that they can be displayed in multiple languages.

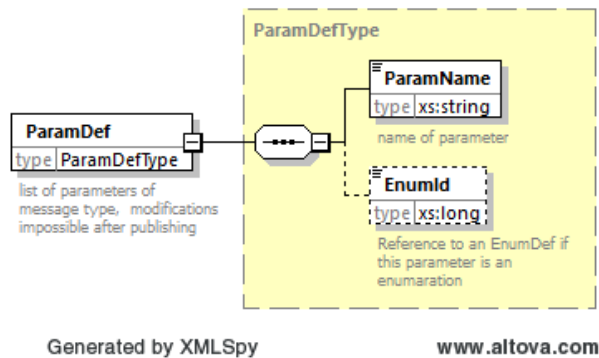

Tag	Description
ParamName	Name des Parameters.
EnumId	If an enumeration is defined for the parameter values, then the values of the enumeration can be found under this enumeration ID

#### 1.5 Degree

This definition contains the language-specific values of the degree of a message.

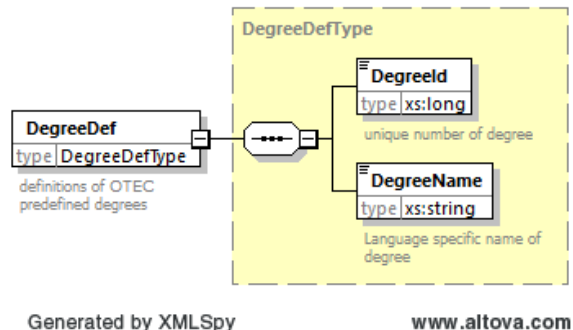

Tag	Beschreibung
DegreeId	Unique number of degree

Tag	Beschreibung
DegreeName	Language-specific name of the degree

In the message itself, the ID is transferred for the degree.

The default degree are recommended:

- 0 Info
- 1 Warning
- 2 Error
- 3 fatal error

Others can be defined on a project-specific basis.

## 1.6 Message Categories

This definition includes the language-specific message categories. An example of assigning the message category name would be "LSA" or "Signs".

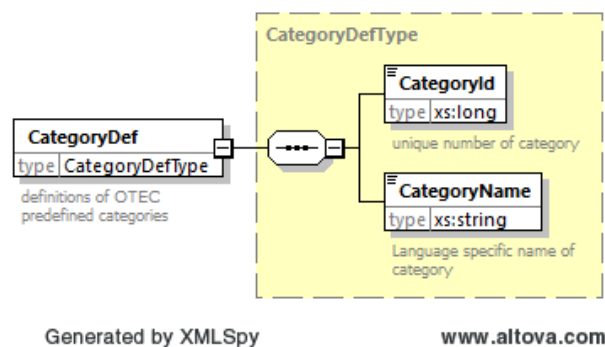

Tag	Description
CategoryId	Identification of the notification category.
CategoryName	Language-specific name of the message category

In the message itself, the ID for the category is transferred.

## 1.7 Enumerations

Enumerations allow language-specific texts.

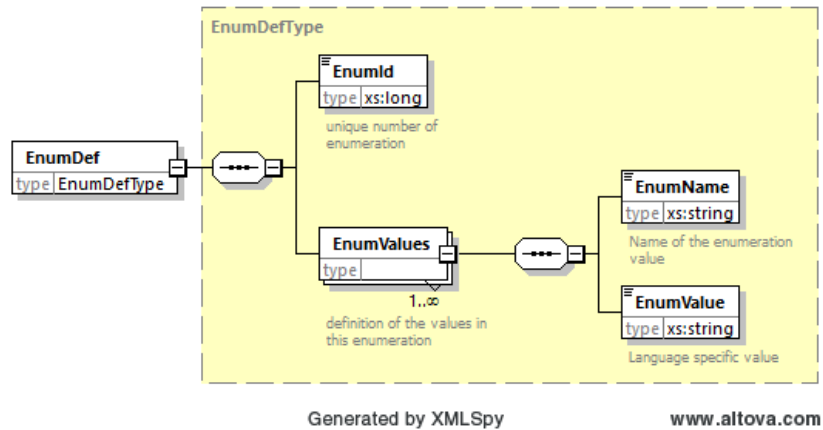

Tag	Description
EnumId	Identification of the enumeration.
EnumName	Enumeration name
EnumValue	Language-specific text of the enumeration

In the message, the respective enumeration name is transferred for the parameter as the current value. The name for the individual values should be a text that can be understood without translation. This makes it possible for the message to be understood even on systems that do not convert the enumeration name into language-specific texts.

OCIT-C\_MessageDefinition\_exchange\_V2.1\_A01

Copyright © 2024 ODG & Partner

---